

Data Sheet



Article number: 586142186

Description: Push-on fitting 14.218-6, metal $\text{Ø}6/4\text{-G } 1/8\text{'-Ø}6/4$
Banjo Tee

Measures

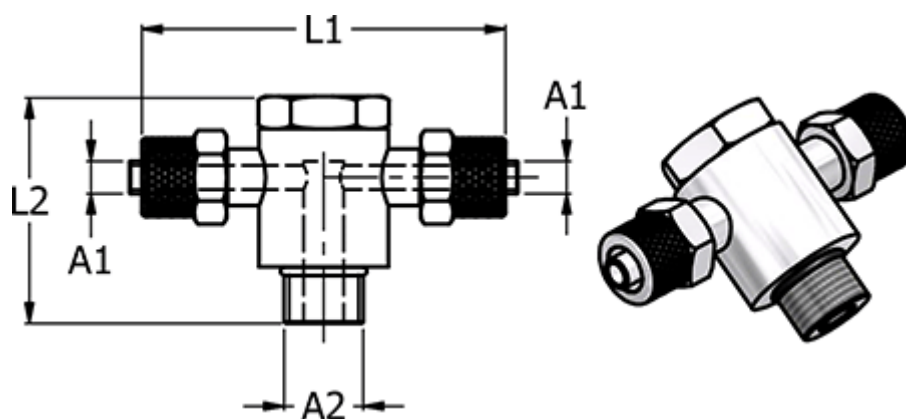

Hose diameter A1	= 6/4
L1	= 49.0
L2	= 28.0
NV	= 14
Thread A2	= G 1/8"